



BROWN SAFE

The **MAN SAFE**



The MAN SAFE - Luxury Watch Safe Series

The Man Safe series of luxury burglary safes are designed and created specifically for the needs of the modern man. This unit is manufactured expressly for the watch enthusiast who demands the finest protection, organization, and convenient storage for their timepieces.

Given Brown Safe's long standing reputation for building high security safes, The Man Safe presents a convenient and secure jewelry storage solution for the discerning client seeking only the best of the best.

This design guide will assist you in creating the perfect safe to meet your individual needs and reflect your personal style.

As you go through this design booklet, you will be given different options and choices for your new safe. Simply check the boxes to make your selections and create your custom Man Safe. For further information and specifications you can also review the material on our website at BrownSafe.com.

Need help selecting the right safe? View our complete [Safe Buying Guide](#).

Our knowledgeable and friendly designers are here to help if you have any questions.

(760) 233-2293

Sales@BrownSafe.com



Select Man Safe Size:

1418

2018

4018

6018

6024

6037

To best suit your watch and jewelry storage requirements, the Man Safe is available in six standard sizes.



Custom Size

Enter exterior dimensions (in inches) below:

Height:

Width:

Depth:

Man Safe 1418
Interior Configuration:

Configuration 1

Configuration 2

Configuration 3

Or

Custom
Configuration

*4 winders per row

**12 winders max with no
drawers

Number of
winders desired:

Number of
drawers desired:

The Man Safe 1418 is our smallest luxury safe offering, making it the ideal solution for a convenient high-security safe in areas where space is at a premium.

Available in three interior configurations:

Man Safe 1418 Interior Configuration #1:

- 5" open space
- One 1.5 inch drawer
- One 2 inch drawer

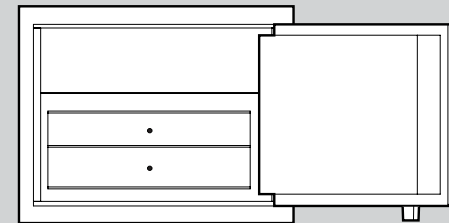

Man Safe 1418 Interior Configuration #2:

- Four watch winders
- One 1.5 inch drawer
- One 2 inch drawer

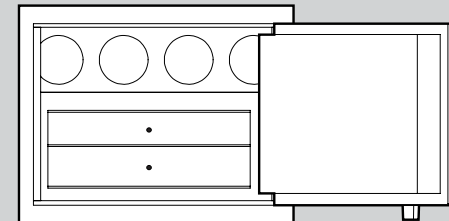

Man Safe 1418 Interior Configuration #3:

- Eight watch winders
- One 1.5 inch drawer

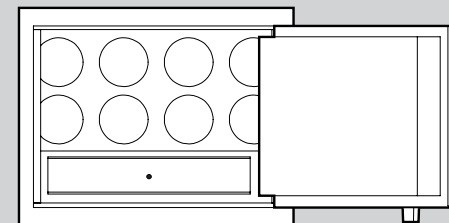

Man Safe 2018
Interior Configuration:

Configuration 1

Configuration 2

Or

Custom
Configuration

*4 winders per row

**16 winders max with no
drawers

Number of
winders desired:

Number of
drawers desired:

The 2018 is a compact safe with comprehensive security and luxury appointments. The size of this model allows for easy placement in most locations, and provides enough space to easily access your favorite valuables for daily use.

Available in two interior configurations:

Man Safe 2018 Interior Configuration #1:

- 4 watch winders
- One 2 inch drawer
- One 3 inch drawer
- 3.5 inch open space below drawers

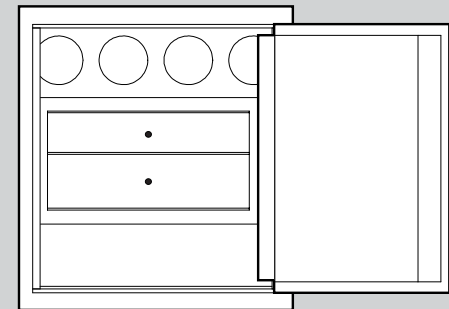

Man Safe 2018 Interior Configuration #2:

- 8 watch winders
- One 2 inch drawer
- One 3 inch drawer

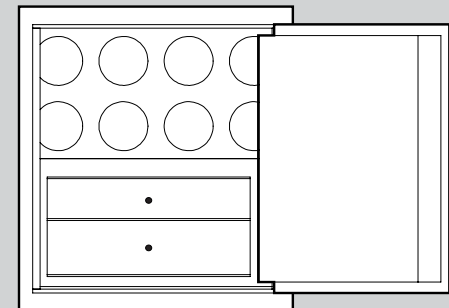

Man Safe 4018
Interior Configuration:

Configuration 1

Configuration 2

Configuration 3

Or

Custom
Configuration

*4 winders per row

**36 winders max with no
drawers

Number of
winders desired:

Number of
drawers desired:

The 4018 is our midsize Man Safe and our most popular model. Ample size combines with luxurious amenities to create the perfect modern safe for the discerning man.

Available in three interior configurations:

Man Safe 4018 Interior Configuration #1:

- 4 Watch Winders
- Two 2 inch drawers
- One 3 inch drawer
- One 5 inch drawer
- 12 inch open space below drawers

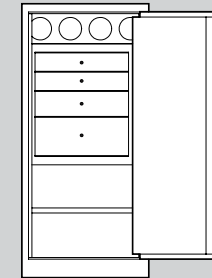

Man Safe 4018 Interior Configuration #2:

- 8 Watch Winders
- Two 2 inch drawer
- One 3 inch drawer
- One 5 inch drawer
- 8 inch open space below drawers

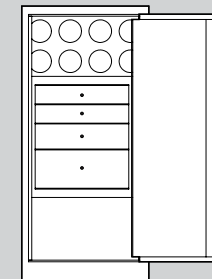

Man Safe 4018 Interior Configuration #3:

- 12 Watch Winders
- One 2 inch drawer
- One 3 inch drawer
- One 5 inch drawer
- 8 inch open space below drawers

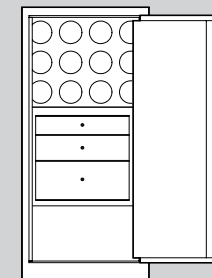

Man Safe 6018
Interior Configuration:

Configuration 1

Configuration 2

Or

Custom
Configuration

*4 winders per row

**56 winders max with no
drawers

Number of
winders desired:

Number of
drawers desired:

The height of the 6018 allows for convenient access to the watch panel, chest of drawers, and open space. Its commanding presence and larger capacity is the preferred choice for the serious watch collector, and for those whose needs demand a full-size high-security luxury safe.

Available in two interior configurations:

Man Safe 6018 Interior Configuration #1:

- 16 watch winders
- Two 2 inch drawers
- One 3 inch drawer
- One 5 inch drawer
- 20 inch open space below drawers

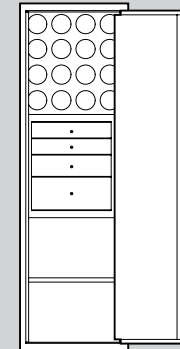

Man Safe 6018 Interior Configuration #2:

- 32 watch winders
- One 2 inch drawer
- One 3 inch drawer
- One 5 inch drawer
- 8 inch open space below drawers

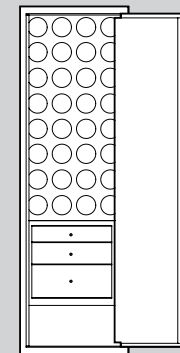

Man Safe 6024
Interior Configuration:

Configuration 1

Configuration 2

Or

Custom
Configuration

*4 winders per row

**56 winders max with no
drawers

Number of
winders desired:

Number of
drawers desired:

The 6024 adds a six inch wide slot for the storage of long guns, while retaining the popular interior configurations of watch winders and drawers from the 6018 model.

Available in two interior configurations:

Man Safe 6024 Interior Configuration #1:

- 16 watch winders
- Two 2 inch drawers
- One 3 inch drawer
- One 5 inch drawer
- 20 inch open space below drawers
- Space for 2 long guns on hinge side

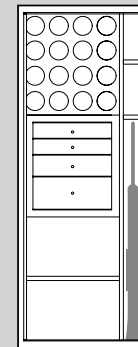

Man Safe 6024 Interior Configuration #2:

- 32 watch winders
- One 2 inch drawer
- One 3 inch drawer
- One 5 inch drawer
- 8 inch open space below drawers
- Space for 2 long guns on hinge side

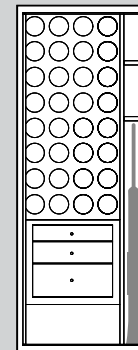

Man Safe 6037
Interior Configuration:

Configuration 1

Configuration 2

Or

Custom
Configuration

*4 winders per row

**112 winders max with no
drawers

Number of
winders desired:

Number of
drawers desired:

The 6037 is the perfect model for the modern man seeking secure storage for both fine timepieces and larger gun collections.

Available in two interior configurations:

Man Safe 6037 Interior Configuration #1:

LEFT SIDE

- Gun rack for 10-11 long guns
- 9 inch open space above gun area

RIGHT SIDE

- 16 watch winders
- Two 2 inch drawers
- One 3 inch drawer
- One 5 inch drawer
- 20 inch open space below drawers

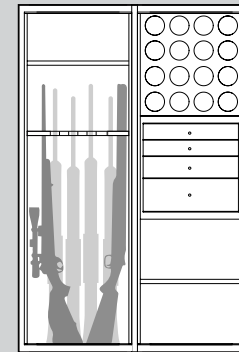

Man Safe 6037 Interior Configuration #2:

LEFT SIDE

- 32 watch winders
- One 2 inch drawer
- One 3 inch drawer
- One 5 inch drawer
- 8 inch open space below drawers

RIGHT SIDE

- 32 watch winders
- One 2 inch drawer
- One 3 inch drawer
- One 5 inch drawer
- 8 inch open space below drawers

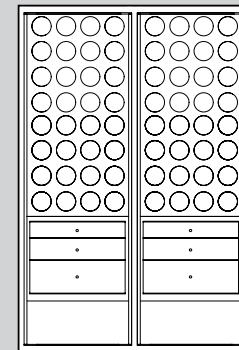

Select Protection Level

Man Safe
Class B Rating

Man Safe ELITE
Class M Rating
With Ballistic Armor

Man Safe - Class B Rating

A Class B security safe is equipped with a 1/2 inch solid steel door and 1/4 inch solid steel walls on all 5 sides. At its core, this is a safe with a substantial foundation, one capable of easily resisting hours of brute force abuse by amateur criminals.

These safes will generally be capable of withstanding entry attempts by semi-skilled criminals for an hour or more depending largely on the types of tools used to attempt entry.

Man Safe ELITE - Class M Rating with Ballistic Armor

The MAN SAFE ballistic model takes advantage of the highest protection level available. It is fully constructed of military grade ballistic armor plate.

The armor plating of an M rated safe is of the same thickness as steel plating from a Class B rated safe but with penetration resistance equaling that of the strongest hardplate material available.

Features of the Elite Security Package include:

- 1/2 inch Ballistic Armor Door
- 1/4 inch Ballistic Armor Body
- Glass Plate Relocking Device
- Chip Carbide Hardplate
- 3 way bolt work with anti-drive system

Please note

3 way boltwork is not included on 1418 and 2018 models.

Glass plate relocking device not included on 1418 model.



One major challenge our M rated safes have already passed consists of firing multiple 50 caliber anti-sniper bullets directly into the safe. Aside from the missing paint, the safe shows little to no visible indentation, a feat no other known safe is capable of achieving, and a testament to the incredible strength of these safes.

This armor also resists conventional penetration entry attempts. Carbide tipped drill bits, for instance, have little to no success at boring through as the armor hardness is an even match to that of the bits.

Select Fire Protection

Yes

No

Fire Protection Specifications

Selecting fire protection adds an innovative fire-resisting concrete amalgamate which protects the ManSafe Series from temperatures up to 1700°F for 90 minutes and increases security rating to UL TL-15.

An intumescent door seal protects the contents of the safe by expanding and filling any openings to block the movement of flames and retard the transfer of heat and smoke.

Considerations when deciding on Fire Protection

Fire protection will change the outside dimensions of the safe by increasing the safe width and height approximately 4" and increasing the depth by approximately 5". Fire protection will also increase the weight of the safe significantly and may prevent second floor installations of the larger safe models.

*For further information regarding specific safe sizes please reference the individual model specification sheets located at www.BrownSafe.com

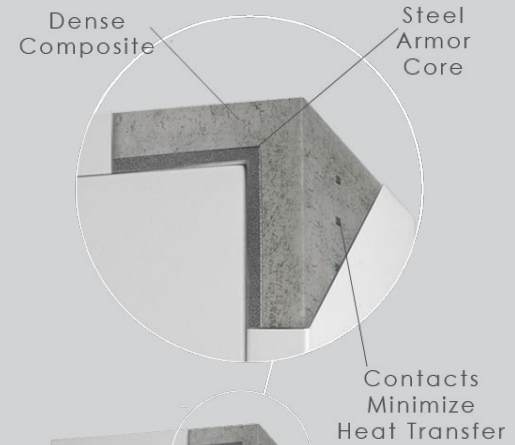

TL-15



Select Exterior Color

- Pure White
- Antique White
- Sierra Tan
- Regal Red
- Windsor Blue
- Espresso Brown
- Coach Black

Custom Color

Manufacturer:
 Paint Code/Name:
 Sheen:
 *Gloss sheen recommended

All Man Safes undergo a multi-stage paint process to provide the most refined exterior finish available, resulting in a hardened paint finish which is then polished to a high gloss.

Below are samples of our standard paint colors:



Pure White Antique White Sierra Tan Regal Red Windsor Blue Espresso Brown Coach Black





Select Lock Finish

Satin Black

Brushed Stainless

Man Safes are offered in two metal finish choices for your safe's exterior lock and handle. Choose either the stealthy all Black Anodized finish or the cool modern finish of Brushed Stainless.



Satin Black



Brushed Stainless



Select Entry Method

Electronic Lock

Electronic Lock with
Tri-Spoke Handle

Biometric Lock

Biometric Lock with
Tri-Spoke Handle

With the MAN SAFE you can choose between two simple-to-use locks that give you instant access whenever you need it most.

ELECTRONIC KEYPAD LOCK

This U. L. Listed Type 1 high-security Lock offers reliable convenience at your fingertips. Made by La Gard, one of the most reputable lock makers in the industry. This industrial grade lock has proven its worth over many years of both commercial and residential service.

BIOMETRIC FINGERPRINT LOCK

This luxury lock offers the ultimate in security and ease of use. The fingerprint reading lock comes encased in a highly ruggedized housing custom machined from solid aerospace grade aluminum for increased outer lock protection, and the ergonomic position of the biometric fingerprint reader along with the integrated handle allows for effortless access.

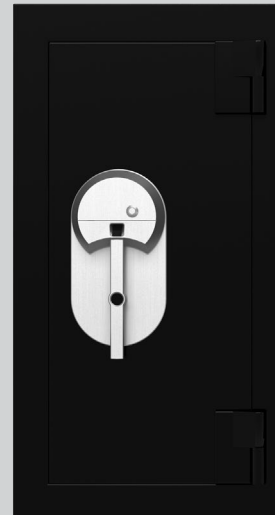
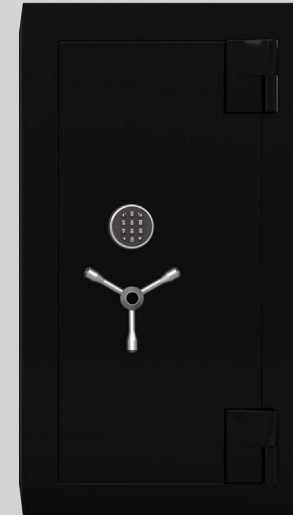
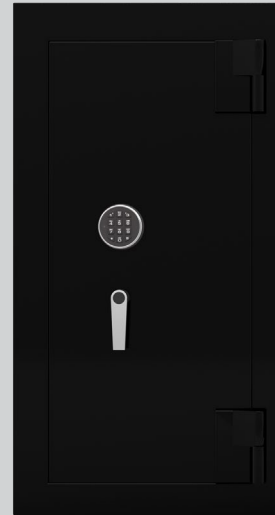

Select Hinge Location

Left Swing Door

Hinges located on left side when facing safe.

Safe door opens from right to left.

Right Swing Door

Hinges located on right side when facing safe.

Safe door opens from left to right.

The Man Safe comes with a standard right hand door swing, but can be built with a left hand door swing to fit your individual needs.



Optional Left Hand Hinge Location



Standard Right Hand Hinge Location

Select Door Swing

Standard:

135 Degree Door Swing

Safe door must open to a minimum 135 degrees to pull drawers out of safe.

If you cannot get the door to 135 degrees, please select the 90 degree option.

Optional:

90 Degree Door Swing

Safe door only needs to open to 90 degrees to pull out drawers.

Width of drawers reduced to clear safe door at 90 degrees.

Select this option if there is any concern with getting the door to the full 135 degree clearance.

Please Note:
Both options will allow for the door to open up to 180 degrees if space permits.

The MAN SAFE is available with either 90° or 135° door clearance. When space is limited or when the safe is located in such a way that the door can't open a full 135° to fully extend the drawers, then a 90° door configuration should be selected. The 90° door swing option reduces drawer width so they can be fully extended when the door is open to a minimum of 90°.

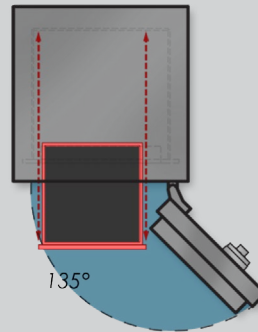

Standard 135 Degree Door Swing

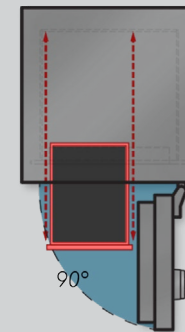

Optional 90 Degree Door Swing

*Note: Both door swing options will allow the door to open as far as space will permit up to 180°

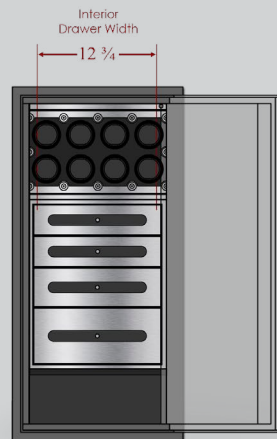

135° Door Swing



90° Door Swing*



90° Door Swing*
with fire protection

Models with fire protection require additional clearance. The resulting open space on the hinge side is lined in matching fabric and receives adjustable shelves.

Select Interior Finish

Standard Interior:

Macassar Ebony

Custom Wood

Name of wood:

Upgraded Interior:

Stainless Steel Package:

Brushed Stainless
& Black Anodized

Brushed Stainless
& Carbon Fiber

Signature Leather Package:

Havana Leather

Black Leather

Custom Leather

Color of Leather:

The interior trim and jewelry chest of all Man Safes are custom built to your selection of hand crafted finishes below:

Standard Interior

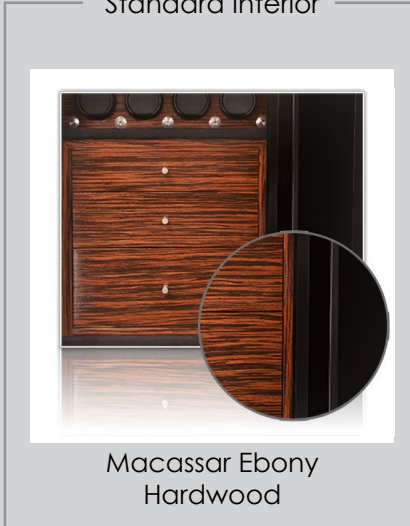

Macassar Ebony
Hardwood

Upgraded Interior



Brushed Stainless
& Black Anodized



Brushed Stainless
& Carbon Fiber

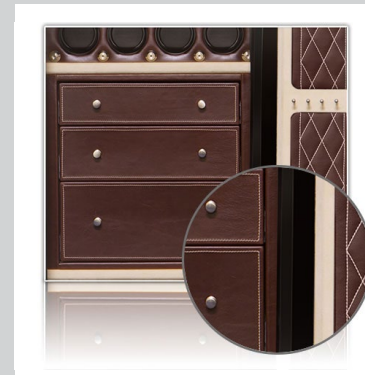

Havana Leather

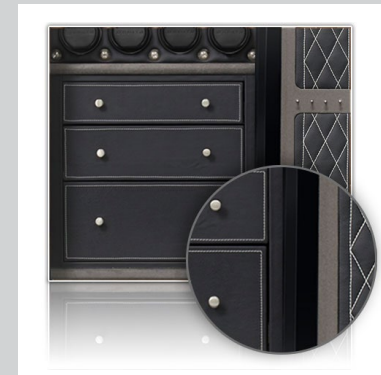

Black Leather



Select Interior Fabric

Black Ultrasuede™

Sand Ultrasuede™

Gray Ultrasuede™

Custom Ultrasuede™ Color

Color Name:

Custom Leather Color

Color Name:

The interior fabric covers all adjustable shelves, walls and lines the drawers.

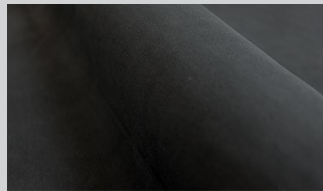

Black Ultrasuede™

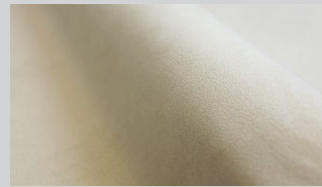

Sand Ultrasuede™



Gray Ultrasuede™



Custom Color Ultrasuede™



Custom Color Leather



Select Drawer Layouts

Please use your chosen interior configuration below:

Single Drawer Configuration



Drawer 1

Two Drawer Configuration



Drawer 1
Drawer 2

Three Drawer Configuration



Drawer 1
Drawer 2
Drawer 3

Four Drawer Configuration



Drawer 1
Drawer 2
Drawer 3
Drawer 4

Layout A
Large Compartments



Compartment Size: 2 1/4" x 3"
Cost = \$75

Layout B
Small Compartments

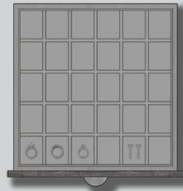

Compartment Size: 1 3/4" x 2 1/4"
Cost = \$75

Layout C
Ring Slots



Storage For 100 Rings
Cost = \$75

Layout D
Grooved Jewelry Holders



Great For Pins, Rings & Earrings
Cost = \$75

Layout E
Grooved Jewelry Holders
& Ring Slots



Combination Jewelry
& Ring Layout
Cost = \$75

Layout F
Grooved Jewelry Holders
& Open Compartment



Combination Jewelry
& Open Layout
Cost = \$75

Layout G
Four Compartments



Compartment Size:
6 1/8" x 6 1/4"
Cost = \$75

Layout H
Horizontal Dividers



Bracelets, Watches and Chains
Cost = \$75

Layout I
Watch Compartments

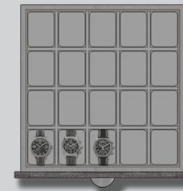

Watch and Bracelet Slots
With Pillows
Cost = \$135

Layout J
Flat Watch Drawer



Flat Storage For Watches
Five 2 1/4" x 12 3/4" Compartments
Cost = \$75

Layout K
Pen Drawer



Storage For Up To 20 Pens
Cost = \$75

Layout L
Man Drawer



Half Pen Storage and Half Storage
For Watches & Jewelry
Cost = \$75

Layout M
Currency Drawer



Compartments For Passport
& Cash Storage
Cost = \$75

Layout N
Travel Drawer



Compartments For Passports
& Travel Documents
Cost = \$75

Layout O
Jewelry Layout
With Necklace Form

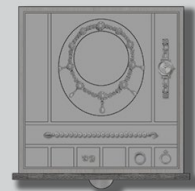

Perfect Storage Option For
Matching Jewelry Sets
Cost = \$105

Layout P
Jewelry Drawer 1



Grooved Jewelry Holder, 2 1/4" x 2"
Compartments, & Horizontal Dividers
Cost = \$75

Layout Q
Jewelry Drawer 2

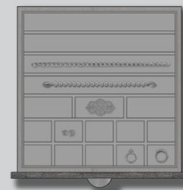

Ten 2 1/4" x 1 3/4", Three 4" x 1 3/4"
Compartments, & Horizontal Dividers
Cost = \$75

Layout R
Jewelry Drawer 3

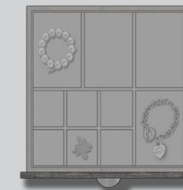

Six 2 1/2" x 3" & Four 4" x 6 1/4"
Jewelry Compartments
Cost = \$75

*Note: All drawers have an open layout as standard.

Select Security Upgrades

Glass Plate Relocking Device
(Not available on 1418)

Silent Signal Alert

Bolt Lock Indicator

Multi-Sensor Alarm
(Combines Silent Signal Alert & Bolt Lock Indicator)

Glass Plate Relocking Device *(Standard on Elite protection level models)*

- Provides added burglary protection.
- Increased sensitivity against forced entry attacks.
- Glass plate shatters setting off relockers at an early stage in the burglary, increasing the difficulty of entry.



Silent Signal Alert

- Triggered by either a hidden button or an alternate unlock entry code, safes equipped with the silent signal alert feature interface directly with your alarm or home automation system.
- With the silent signal feature in place, if the unfortunate situation ever arises where the safe owner is forced to open the safe against their will, the safe can be unlocked in a normal manner while an undetectable alert is secretly sent to the homes monitoring system which in turn relays a message to security authorities, immediately alerting them to the holdup situation.



Bolt Lock Indicator

- Allows the home automation system to monitor all safe entries and notify the owner any time the safe is accessed, or raise an alert if the safe is opened while the owner is away from home.



Multi-Sensor Alarm

- Combines both the silent signal alert and bolt lock indicator security features into one advanced security upgrade.



Select Watch Winders

Standard:

Rotorwind Winders

Upgrade:

Programmable
Winders

Additional Winders

Enter Number of
Winders Desired

**Four winders per row

In an effort to provide watch collectors years of dependable operation all Man Safes make use of high quality Orbita watch winders, the recognized leader in automatic watch winder technology.

All Man Safe models come as standard with Orbita Rotorwind watch winders, or timepiece collectors can choose to upgrade to Orbita Programmable winders.

Orbita Rotorwind Winders

This design is unique in that it swings an automatic watch, rather than rotating it, to mimic the natural action of the wrist. These are recommended for most clients because they work with the majority of automatic watches and are a great solution for those who do not want to program each winder individually.

Orbita Programmable winders

This classic design employs a sophisticated microprocessor control for winding cycles of 650, 800, 950, 1,300, or 1,600 turns per day, with a choice of clockwise, counter-clockwise or automatic reversing rotation. These are recommended for watches with complex movements or collectors who desire more control over the winding parameters.

To best suit the needs of your watch collection, the Man Safe can be fitted with additional watch winders. If standard Man Safe models don't offer enough storage for your timepieces, consider opting for a larger watch winder panel made for your collection.

Note: additional winders are added in sets of 4 per row.





Add a Watch Window?

Yes

* Not available on 1418 or 2018 models

No

The Man Safe line of luxury watch safes are a top choice for protecting priceless watch collections. Now collectors of fine timepieces can display their watches at all times while maintaining the highest degree of protection with the ballistic window versions of the Man Safe.

Watch winder display windows are currently available in both the Man Safe 4018, 6018, 6024, and 6037 models. Each safe is custom built to suit the owner's needs and configured to their personal watch collection. Please contact a Brown Safe representative to learn more.



Watch Display Window shown on 4018 model for reference.

Select Luxury Upgrades

Necklace/Key Rack

Pistol Rack

Pedestal Riser

6" (standard)

— Custom Height (min 3")

Custom Flared Pedestal Riser

6" Height

12" Height

Necklace/Key Rack (Not Available with 3 way boltwork)

This convenient upgrade takes perfect advantage of the open space on the interior of the door. The simple metal pins and matching hardwood or leather backing provides a great way to display and easily access keys, necklaces, bracelets, and other favorite hanging items.



Pistol Rack (Not Available with 3 way boltwork)

These adjustable handgun holders make use of the open space on the door interior to create a convenient and stylish way to secure your pistols. Accommodates most modern semi-auto pistols.



Pedestal Riser

- Elevates the safe to an optimum height for quick and easy access.
- Pedestal heights start at 3" but can be custom built in 1/2" increments to the exact height requested.

**If you are considering a pedestal over 6 inches we highly recommend selecting the next size larger safe. Typically the price of a tall pedestal exceeds that of the next largest safe size and you gain the benefit of extra storage space to secure your valuables.*

Custom 6" or 12" Flared Pedestal

- Elevates the safe to a more convenient level for enhanced access and use.
- The solid steel base is built to match the selected MAN SAFE protection level.
- This stylish pedestal is clad in machined aerospace grade aluminum and nickel plated to produce a refined low-luster finish.



MAN SAFE 4018 on 6" Pedestal Riser.



MAN SAFE 4018 on 6" Flared Pedestal Riser.

Thank you for Choosing
The **MAN SAFE**

WE'LL ARRANGE ALL DELIVERY AND WHITE GLOVE INSTALLATION.

Simply provide your address and we can calculate an accurate shipping quote or call us today to discuss your specific delivery and installation requirements.

FIRST NAME:	LAST NAME:	
EMAIL:	PHONE:	
ADDRESS:	CITY:	
STATE:	ZIP CODE:	COUNTRY:

Please send your selections and one of our knowledgeable sales representatives will contact you to answer any further questions and complete the order.

Phone: 760-233-2293
Email: sales@BrownSafe.com